

Doric MK 4 Chainwinder

with 'built-in' window opening limiter



**WINNER 2009 AWA
DESIGN AWARDS!**



Only 16 winds
from closed to
fully open



Doric

*10 year full replacement warranty against corrosion & mechanical failure.

Technical Specifications

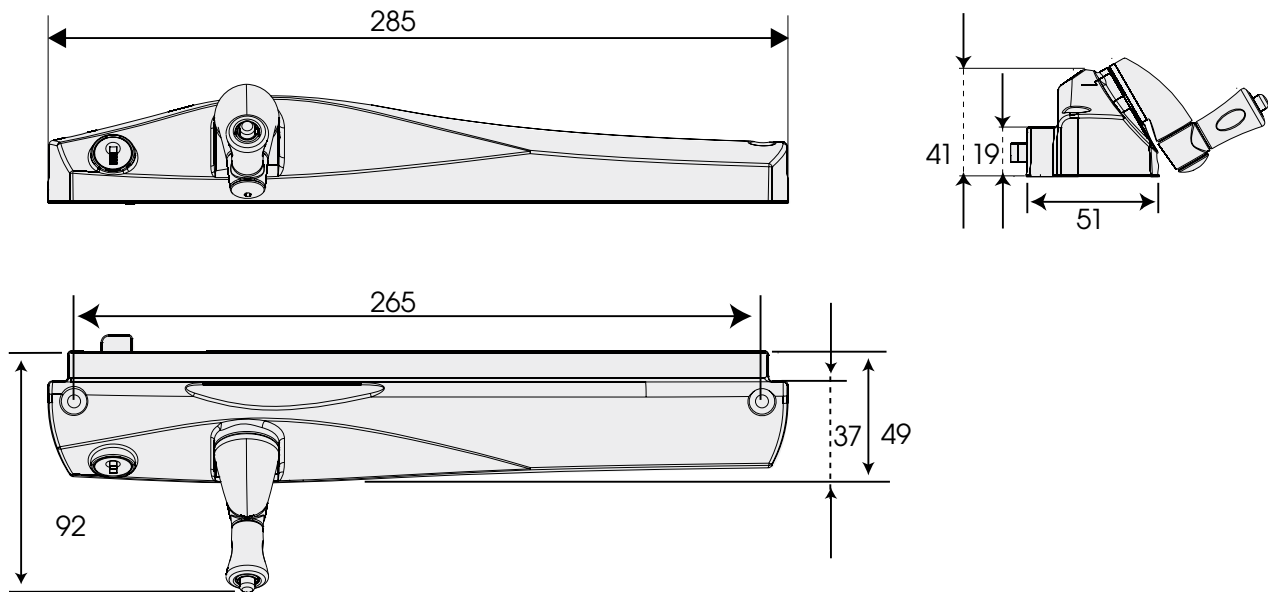

Features

- Patented adjustable chain length limiter feature built-in.
- Lifetime warranty for corrosion on body and base.
- Left and right hand options.
- Only 16 winds to fully open or closed.
- Non-handed fold away lever, finished in chrome plate with simple push button action to eliminate transit damage and interference with drapes.
- Rated to operate a 30kg window.
- Chainwinder footprint similar to existing industry standards allowing easy replacement and retrofitting.
- Stainless steel fixings as standard, for corrosion resistance.
- Optional 304 stainless steel chain for added corrosion resistance, standard chain is gold passivated mild steel.
- Spring back mechanism helps keep chain straight during travel ensuring smooth chain travel.
- Complies with AS2331.3.1 neutral salt spray test Standard (720 hours) and exceeds the AWA Hardware ICP requirements of 96 hours.

Materials:

Polesium™ housing,
 Passivated steel chain standard.
 Optional stainless steel chain
 Chrome plated zinc lever.

Finish:

Available in a full range of powder coat colours.

Cylinder:

Disc cylinders are standard & One Key™ solutions compatible.

Ordering Procedure:

DS177 / SS / DS125 / Black / ALM
 | | | |
 Winder Chain Cylinder Finish Screw Pack

Rating:

30kg window



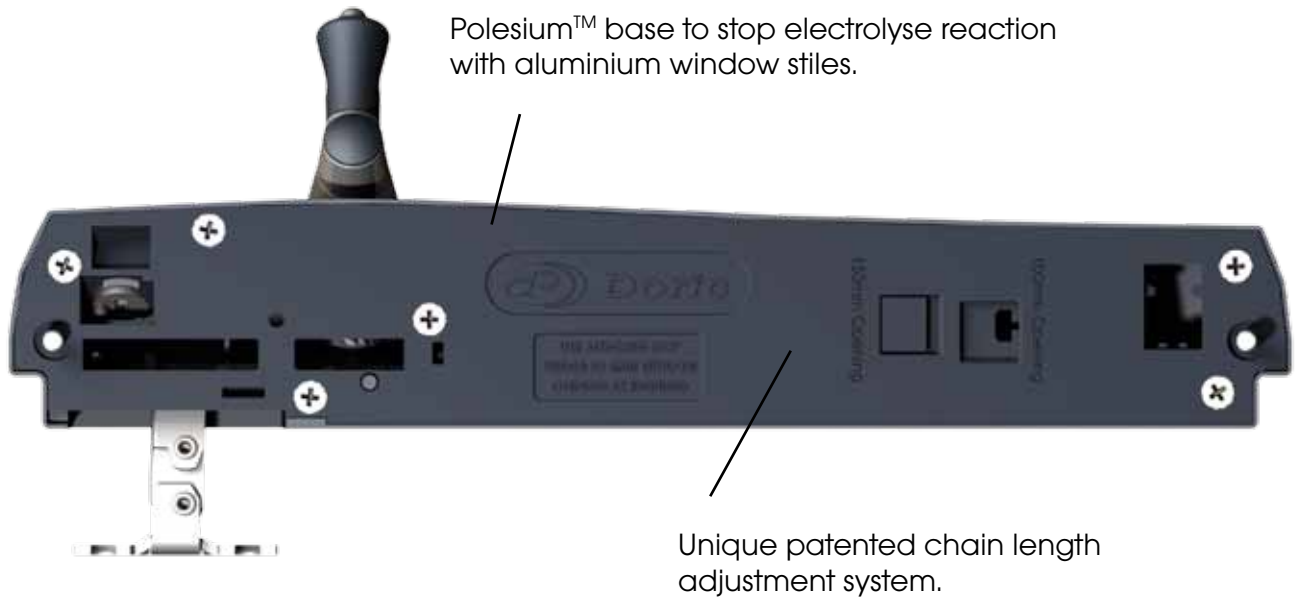

Left and right hand options

Design Award Winning Chainwinder



Non-handed fold away lever, with simple push button action to eliminate transit damage.

Product Options:

WINDER	MATERIAL	CYLINDER	FIXINGS
 DS177 Left hand keyed	stainless steel chain	DS125 5 Wafer Cylinder	Aluminium Frame Screw set "ALUM"
 DS178 Left hand non-keyed	OR	OR	OR
 DS179 Right hand keyed	mild steel chain	DS126 6 Wafer Cylinder	Timber Frame Screw set "TIM"
 DS180 Right hand non-keyed			

DS175 Chainwinder Bracket

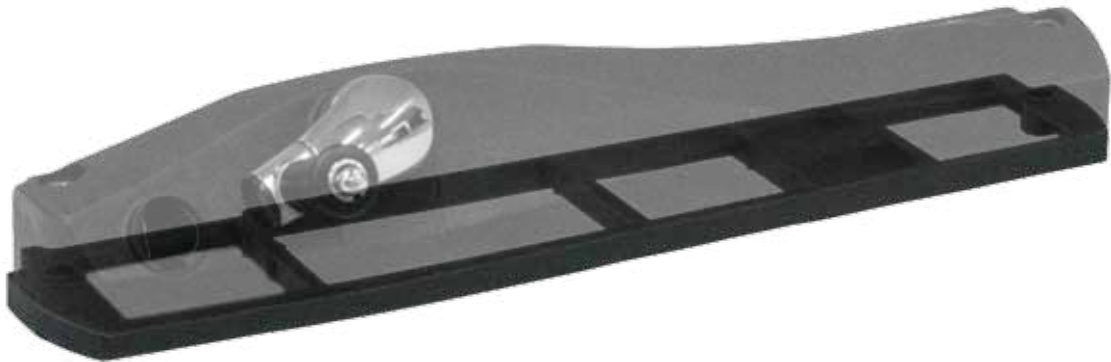

DS175 Chainwinder Bracket

